



COOPERWORKS

INDUSTRIES

Plastic Laminate Casework
SPECIFICATIONS CATALOG

**MADE
IN THE USA**

www.cooperworksind.com

About Us

For over 20 years, MAC Medical, Inc. has manufactured top quality medical equipment including Warming Cabinets, Sinks, Tables, Casework, Case Carts, IV Stands, Mayo Stands, and many other stainless steel products. In keeping with our history of giving customers exactly what they want, we are excited to introduce **Cooperworks Industries®**, a division of MAC Medical, Inc. Cooperworks offers Plastic Laminate Cabinetry that can be configured to complement many spaces including medical, dental, laboratory, veterinary, educational, and more.

MAC Medical has more than 140 full-time employees operating in a 122,500 square foot manufacturing facility and 8,200 square foot corporate office. The Cooperworks Industries facility provides an additional 48,500 square feet of manufacturing space.

Founded as a solutions-based company, MAC Medical is committed to providing USA-made solutions for projects of all sizes distributed in the United States, as well as in 20 countries worldwide. Backed by over 60 years of combined team experience and the best customer service support in the industry, MAC Medical and Cooperworks Industries have the resources to satisfy your specific project needs.



Cooperworks Industries LLC
A Division of MAC Medical, Inc.
200 Admiral Weinel Blvd.
Columbia, Illinois 62236

Phone: 618-503-9171
Toll Free: 877-302-7755
Fax: 618-476-3337
sales@cooperworksind.com
www.cooperworksind.com



We manufacture the following products:

- Warming Cabinets
- Open & Closed Case Carts
- Surgical Scrub Sinks
- Processing Sinks
- Utility Carts
- Tables
- IV Stands
- Mayo Stands
- Solution Stands
- Linen Hampers
- Kick Buckets
- Step Stools
- Transport Stretchers
- Casework

New!

- Plastic Laminate Casework
- Prep & Pack Workstations
- MR Conditional Products
- Any other stainless steel need



Table of Contents

Plastic Laminate Casework Intro	2
Base Cabinets	4
Open	5
Single Door	5
1/4 Drawer	5
Single Sink	6
Four 1/4 Drawer	6
BBF Pedestal Single File Drawer	6
FF Pedestal Double File Drawer	6
Two Tier Pull Out Roller Shelf	7
Double Door	7
Double 1/4 Drawer Double Door	7
Open Compartment Double Door	8
Open Compartment Double Drawer	8
Lateral File 200# Drawer Slides	8
Single Drawer Double Door	8
Blind Solid Door Corner	9
Blind Single Drawer Single Door	9
Wall Mounted ADA Sink Shroud	9
Locking Sink	10
Double Door ADA Sink / Trash	10
Drawer Housing Single Drawer	10
Drawer Housing Double Drawer	10
Diagonal Corner	11
L-Shape Corner	11
Five Drawer Mobile	12
Single Drawer Double Door Mobile	12
Double Drawer Double Door Mobile	12
Mobile Work Station	12
Single Drawer Desk	13
Double Drawer Desk	13

Wall Cabinets	14
Open	15
Single Solid Door	15
Single Glass Door	15
Double Solid Door	16
Double Glass Door	16
Blind Corner	16
Blind Corner Glass Door	17
Single Solid Door, Glove Dispensing	17
Double Solid Door, Glove Dispensing	17
Corner Solid Door	18
Corner Glass Door	18
Microwave Solid Door	19
One-Tier Wall Shelf	19
Two-Tier Adjustable Wall Shelf	19
High Cabinets	20
Single Solid Door	21
Single Glass Door	21
Double Solid Door	22
Double Glass Door	22
Wardrobe	23
Cabinet Colors	24
Plastic Laminate Countertop Profiles	27
Plastic Laminate Countertop Colors	29
Solid Surface Countertop Profiles	30
Solid Surface Countertop Colors	31
Options & Accessories	32
Sinks	32
Faucets	33
Door Styles	33
Hinges	33
Door Pulls	34
Miscellaneous	34
Green Initiative	36
Warranty Information	37



Wall
Cabinets



High
Cabinets



Base
Cabinets

Plastic Laminate Casework

Cooperworks Industries' full line of plastic laminate Wall Cabinets, Base Cabinets, and High Cabinets can be configured in a number of ways to create the arrangement your facility needs. Choose from solid doors, glass doors, or no doors. Options such as wall shelves and sloping tops are available to further customize your casework to suit your needs. Finally, complete the look with solid surface or laminate countertops offered in a variety of styles and finishes.





Base Cabinets

STANDARD FEATURES

- Self-close hinges
- Superior doweled drawer construction
- 3/4 extension white epoxy 100 lb rated drawer slides
- 3/4-inch moisture resistant plywood toe kick

OPTIONS & ACCESSORIES

See pages 32-35.

- Locks
- Hinges
- Pulls
- Slides
- Loose Plywood Base
- Loose Stainless Steel Base
- Loose Stainless Steel Toe Kick Skin (3-7/8" x 96" field cut to size)

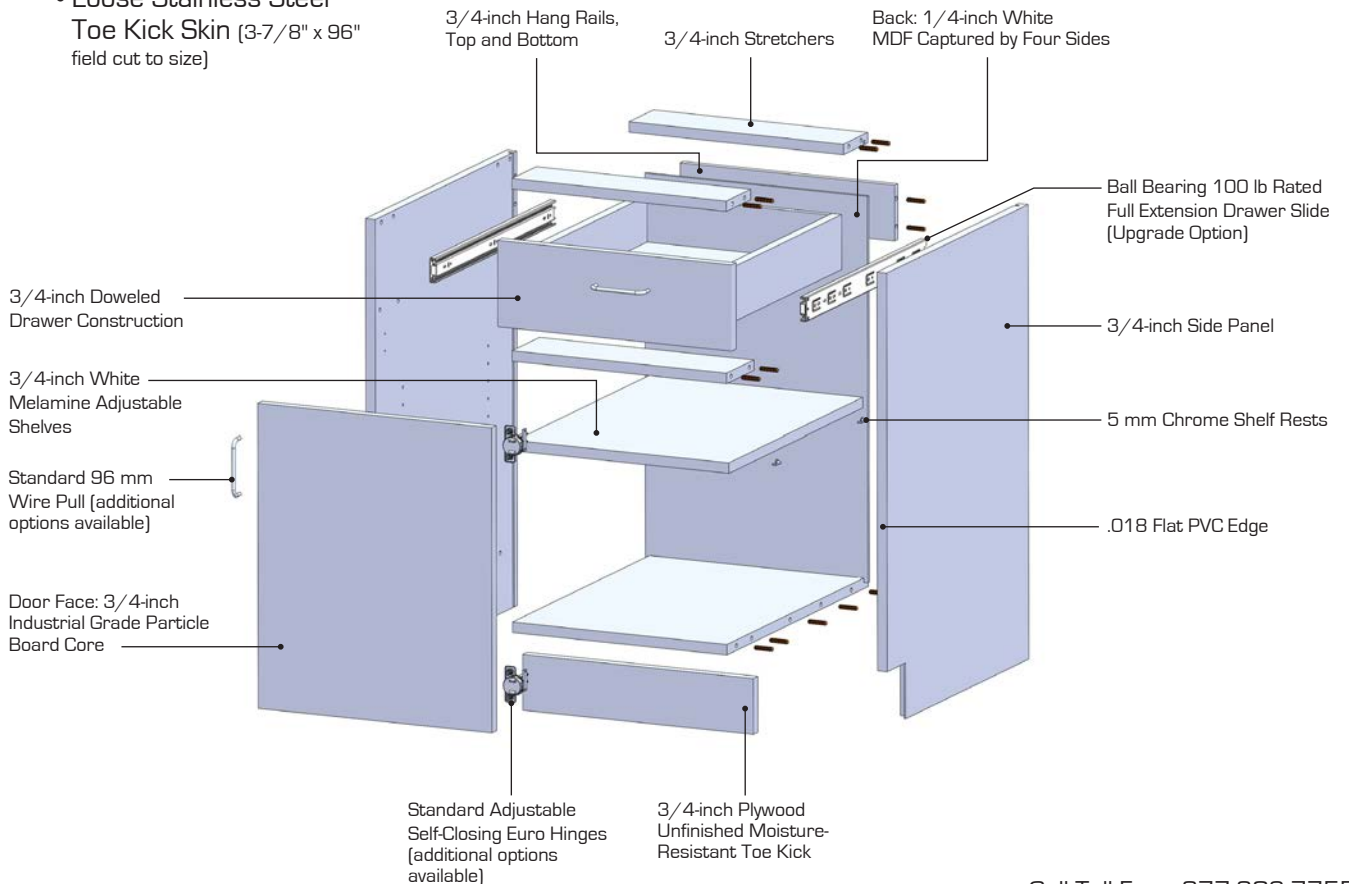
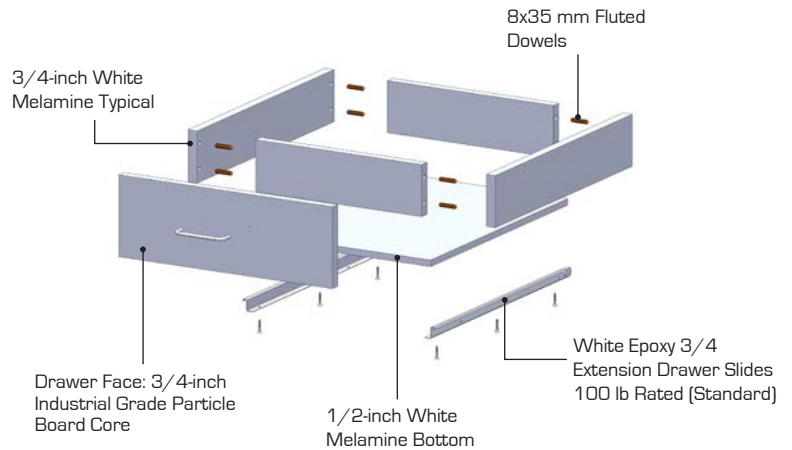

Base Cabinets

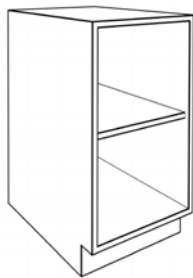
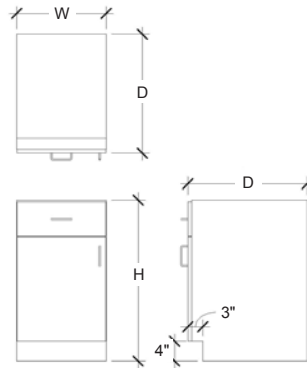

LB100			
Width	Height	Depth	Description
12"	28.5"	18"	Open Base Cabinet
15"	32.5"	21"	(1-2) Adjustable Shelves
18"	34.5"	24"	Exposed Interior Matches Exterior
21"		29"	
24"			
27"			
30"			
33"			
36"			

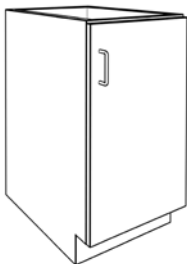

LB101 Left Hinge LB102 Right Hinge (shown)			
Width	Height	Depth	Description
12"	28.5"	18"	Single Door Base Cabinet, L or R
15"	32.5"	21"	
18"	34.5"	24"	(1-2) Adjustable Shelves
21"		29"	
24"			

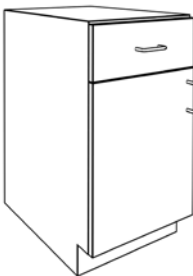

LB103 Left Hinge (shown) LB104 Right Hinge			
Width	Height	Depth	Description
12"	28.5"	18"	1/4 Drawer Door Base Cabinet, L or R
15"	32.5"	21"	
18"	34.5"	24"	(1) Adjustable Shelf
21"		29"	
24"			

Base Cabinets

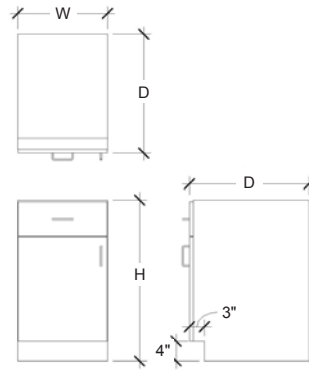

Base Cabinets

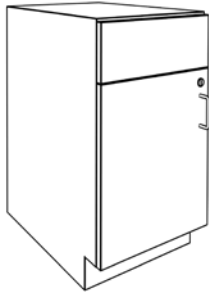

LB105 Left Hinge (shown) LB106 Right Hinge			
Width	Height	Depth	Description
18"	28.5"	18"	Single Sink Base Cabinet Optional Lock
21"	32.5"	21"	
24"	34.5"	24"	
		29"	



LB107			
Width	Height	Depth	Description
12"	28.5"	18"	(4) 1/4 Drawer Base Cabinet
15"	32.5"	21"	
18"	34.5"	24"	
21"		29"	
24"			



LB108			
Width	Height	Depth	Description
16"	28.5"	18"	BBF Pedestal Single File Drawer Base Cabinet
19"		21"	
		24"	
		29"	

*Center drawer height will vary based on total cabinet height.

Note: BBF = Box Box File

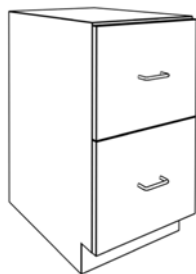

LB109			
Width	Height	Depth	Description
16"	28.5"	18"	FF Pedestal Double File Drawer Base Cabinet
19"		21"	
		24"	
		29"	

Note: FF = File File

Base Cabinets

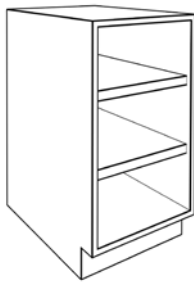
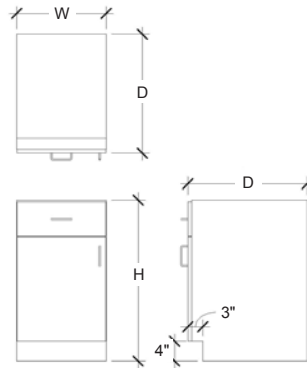

LB110			
Width	Height	Depth	Description
15"	28.5"	18"	Two Tier Pull Out Roller Shelf Base Cabinet
18"	32.5"	21"	
21"	34.5"	24"	[1-2] Adjustable Shelves
24"		29"	Exposed Interior Matches Exterior
27"			
30"			
33"			
36"			

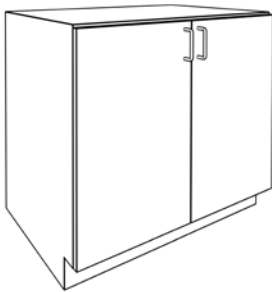

LB120			
Width	Height	Depth	Description
24"	28.5"	18"	Double Door Base Cabinet "Clear Span"
27"	32.5"	21"	
30"	34.5"	24"	[1-2] Adjustable Shelves*
33"		29"	
36"			

*Optional pull out shelves available.



LB121			
Width	Height	Depth	Description
24"	28.5"	18"	Double 1/4 Drawer Double Door Base Cabinet "Clear Span"
27"	32.5"	21"	
30"	34.5"	24"	[1] Adjustable Shelf
33"		29"	
36"			

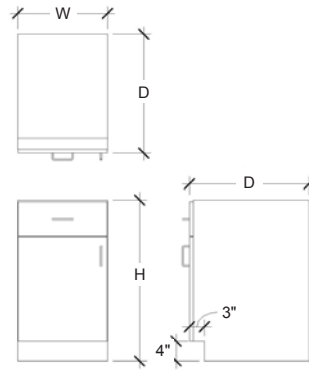

Base Cabinets

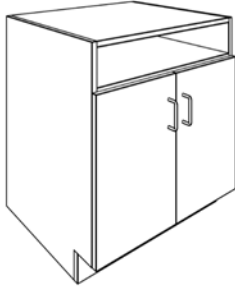

LB122			
Width	Height	Depth	Description
24"	28.5"	18"	Open Compartment Double Door
27"	32.5"	21"	
30"	34.5"	24"	[1] Adjustable Shelf "Clear Span"
33"		29"	
36"			Exposed Interior Matches Exterior



LB123			
Width	Height	Depth	Description
24"	28.5"	18"	Open Compartment Double Drawer
27"	32.5"	21"	
30"	34.5"	24"	[1] Adjustable Shelf "Clear Span"
33"		29"	
36"			Exposed Interior Matches Exterior



LB124			
Width	Height	Depth	Description
27"	28.5"	18"	Lateral File Base Cabinet 200 lb Drawer Slides
30"		21"	
33"		24"	Specify standard or legal files. Legal not available in 18-inch depth.
36"		29"	

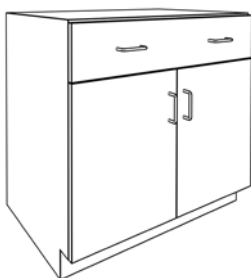

LB125			
Width	Height	Depth	Description
24"	28.5"	18"	Single Drawer Double Door Base Cabinet
27"	32.5"	21"	
30"	34.5"	24"	[1] Adjustable Shelf
33"		29"	
36"			

Base Cabinets

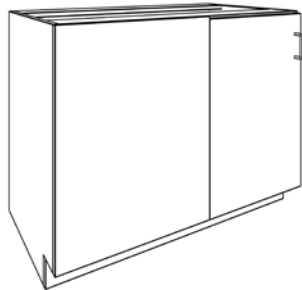
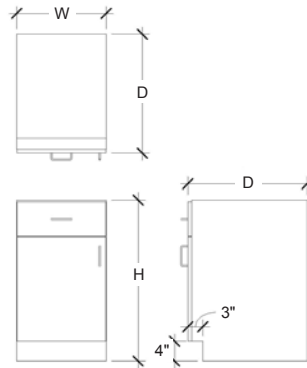

LB126 Left Panel Side (shown) LB127 Right Panel Side			
Width	Height	Depth	Description
39"	28.5"	18"	Blind Full Door Corner Cabinet
42"	32.5"	21"	
45"	34.5"	24"	[1] Adjustable Shelf



LB128 Left Panel Side (shown) LB129 Right Panel Side			
Width	Height	Depth	Description
39"	28.5"	18"	Blind Single Drawer Over Single Door Base Cabinet
42"	32.5"	21"	
45"	34.5"	24"	[1] Adjustable Shelf

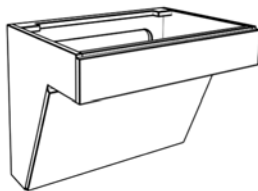

LB140			
Width	Height	Depth	Description
30"	28.5"	21"	Wall Mounted ADA Sink Shroud
33"	32.5"	24"	
36"	34.5"	29"	
39"			
42"			

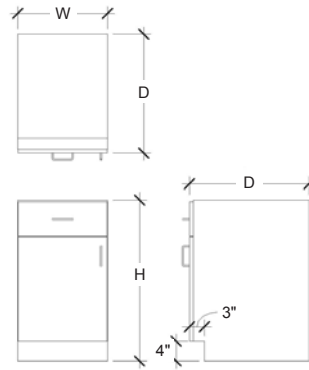

Base Cabinets

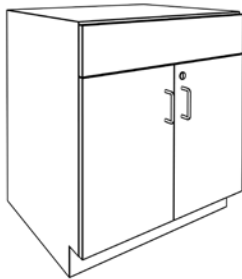

LB141			
Width	Height	Depth	Description
24"	32.5"	18"	Sink Base Cabinet (No Shelves) Optional Lock
27"	34.5"	21"	
30"		24"	
33"		29"	
36"			
39"			
42"			



LB142			
Width	Height	Depth	Description
24"	32.5"	18"	Double Door ADA Sink/Trash (24- and 27-inch Not ADA) No bottom in cabinet Unfinished toe kick attached to door Not available with loose toe kick option
27"	34.5"	21"	
30"		24"	
33"		29"	
36"			
39"			
42"			

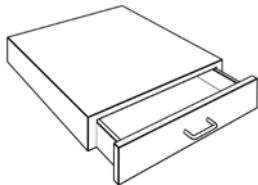

LB150			
Width	Height	Depth	Description
21"	4"	18"	Drawer Housing Single Drawer Optional Lock
24"	4"		
30"	4"		

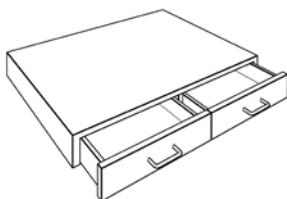

LB151			
Width	Height	Depth	Description
33"	4"	18"	Drawer Housing Double Drawer Optional Locks
36"	4"		
42"	4"		
48"	4"		

Base Cabinets

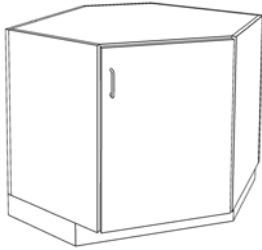
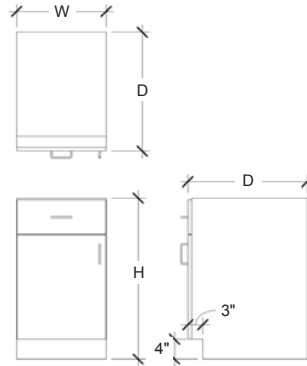

LB160 Left Hinge LB161 Right Hinge (shown)			
Width	Height	Depth	Description
36"	28.5"	36"	Diagonal Corner Base Cabinet
36"	32.5"	36"	
36"	34.5"	36"	(1) Adjustable Shelf

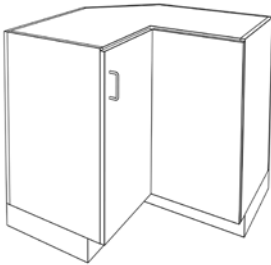
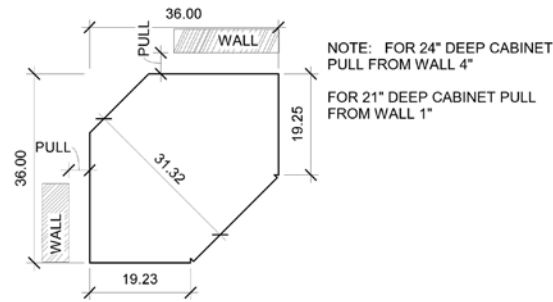

LB162 Left Hinge LB163 Right Hinge (shown)			
Width	Height	Depth	Description
36"	28.5"	36"	L-Shape Corner Base Cabinet
36"	32.5"	36"	(1) Adjustable Shelf
36"	34.5"	36"	Bifold Door Design

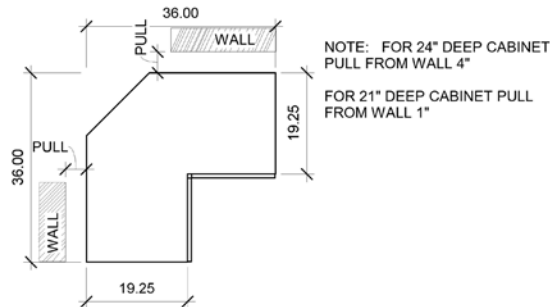

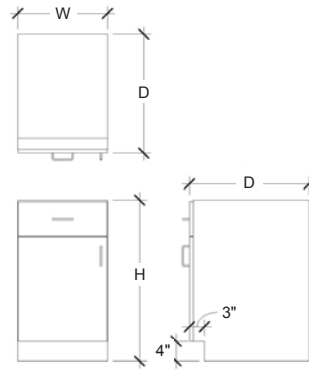

Base Cabinets



LB170			
Width	Height	Depth	Description
18"	28"	18"	(5) Drawer Mobile Cabinet 3/4" Finished Top Included For Countertop Upgrades See Options.
21"	32"	21"	
24"	34"	24"	



LB171			
Width	Height	Depth	Description
18"	28"	18"	Single Drawer over Double Door Mobile Cabinet 3/4" Matching Top Included (1) Adjustable Shelf For Countertop Upgrades See Options.
21"	32"	21"	
24"	34"	24"	



LB172			
Width	Height	Depth	Description
18"	28"	18"	Double Drawer over Double Door Mobile Cabinet 3/4" Matching Top Included For Countertop Upgrades See Options.
21"	32"	21"	
24"	34"	24"	

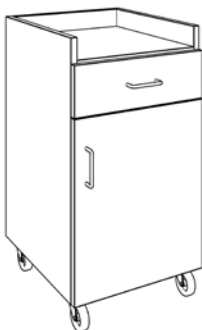

LB173 Right Hinge [shown] LB174 Left Hinge			
Width	Height	Depth	Description
18"	28"	18"	Mobile Work Station (1) Adjustable Shelf
21"	32"	21"	
24"	34"	24"	

Base Cabinets

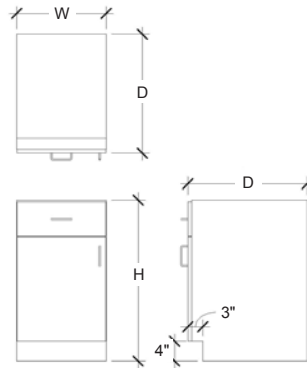

LB180 Left Bracket (shown) LB181 Right Bracket			
Width	Height	End Panel Depth	Description
24"	-	18"	Desk, Single Drawer (Wall Mounted) Assembly required Countertop sold separately
27"	-	21"	
30"	-	24"	
		29"	

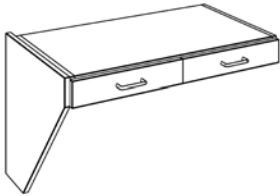

LB182 Left Bracket (shown) LB183 Right Bracket			
Width	Height	End Panel Depth	Description
36"	-	18"	Desk, Double Drawer (Wall Mounted) Assembly required Countertop sold separately
39"	-	21"	
42"	-	24"	
		29"	

Base Cabinets

For questions or to place an order, contact our customer service department at **618-503-9171** or **877-302-7755** or by email at **sales@cooperworksind.com**.

Wall Cabinets



STANDARD FEATURES

- Self-close hinges
- Matching finish on doors and bottoms
- White melamine finished tops

OPTIONS & ACCESSORIES

See pages 32-35.

- Locks
- Hinges
- Pulls
- Light Apron
- Slope Top
- Soffit
- Shelves

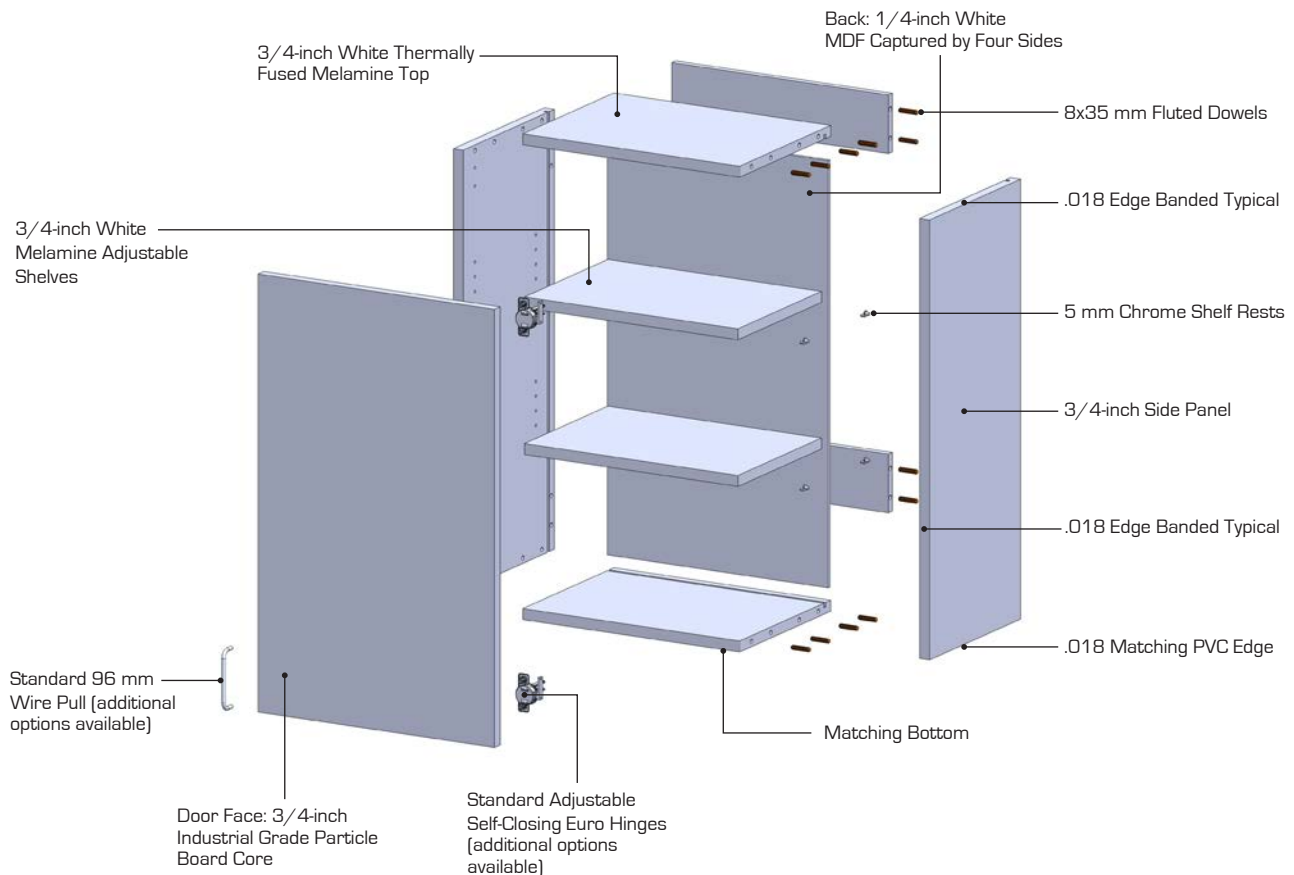

Wall Cabinets

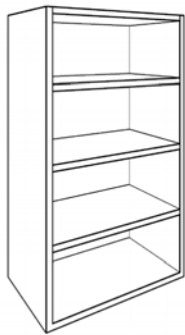
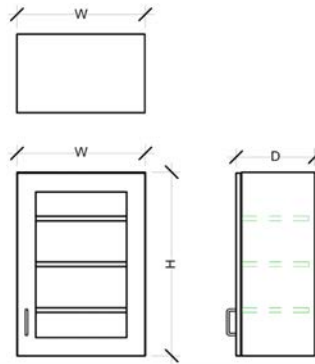

LW100				
Width	Height	Depth*	Shelves	Description
12"	18"	13"	1	Open Wall Cabinet
15"	24"	15"	1	Interior Matches Exterior
18"	30"		2	
21"	36"		2	
24"	42"		3	
27"	48"		3	
30"				
33"				
36"				

*Actual depth dimension: 13"=12" and 15"=14.25"

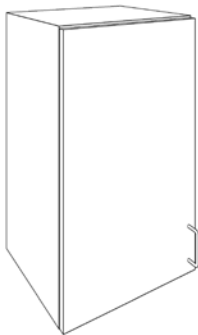

LW101 Left Hinge [shown] LW102 Right Hinge				
Width	Height	Depth	Shelves	Description
12"	18"	13"	1	Single Solid Door Wall Cabinet
15"	24"	15"	1	
18"	30"		2	
21"	36"		2	
24"	42"		3	
	48"		3	



LW103 Left Hinge [shown] LW104 Right Hinge				
Width	Height	Depth	Shelves	Description
12"	18"	13"	1	Single Glass Door Wall Cabinet
15"	24"	15"	1	Interior Matches Exterior
18"	30"		2	
21"	36"		2	
24"	42"		3	
	48"		3	

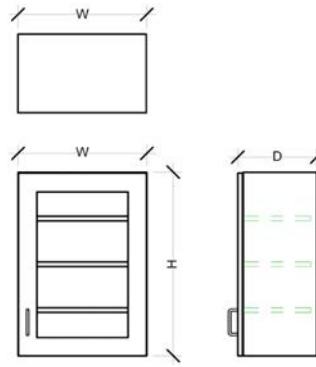

Wall Cabinets

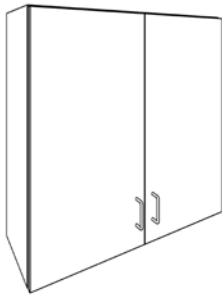

LW110				
Width	Height	Depth	Shelves	Description
24"	12"	13"	0	Double Solid Door Wall Cabinet
27"	15"	15"	0	
30"	18"		1	
33"	24"		1	
36"	30"		2	
	36"		2	
	42"		3	
	48"		3	



LW111				
Width	Height	Depth	Shelves	Description
24"	12"	13"	0	Double Glass Door Wall Cabinet Interior Matches Exterior
27"	15"	15"	0	
30"	18"		1	
33"	24"		1	
36"	30"		2	
	36"		2	
	42"		3	
	48"		3	

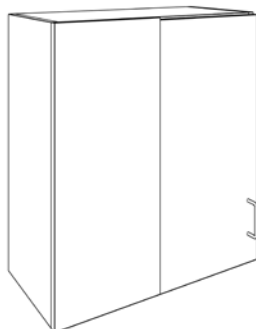

LW112 Left Panel (shown) LW113 Right Panel				
Width	Height	Depth	Shelves	Description
27"	12"	13"	0	Blind Corner Cabinet (Solid Door)
30"	15"	15"	0	
33"	18"		1	
36"	24"		1	
	30"		2	
	36"		2	
	42"		3	
	48"		3	

Wall Cabinets

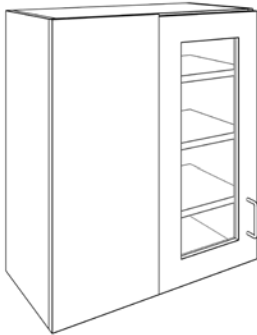
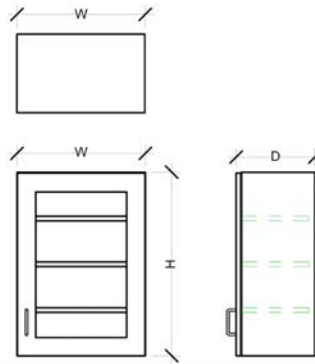

LW114 Left Panel (shown) LW115 Right Panel				
Width	Height	Depth	Shelves	Description
27"	12"	13"	0	Blind Corner Cabinet (Glass Door)
30"	15"	15"	0	
33"	18"		1	Interior Matches Exterior
36"	24"		1	
	30"		2	
	36"		2	
	42"		3	
	48"		3	

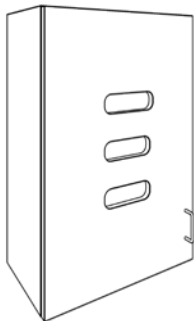

LW120 Left Hinge (shown) LW121 Right Hinge				
Width	Height	Depth	Shelves	Description
18"	30"	13"	0	Single Solid Door Glove Dispensing Wall Cabinet
21"	36"	15"	0	
24"	42"		0	Towel and Cup Dispenser (See Options & Accessories)
	48"		0	

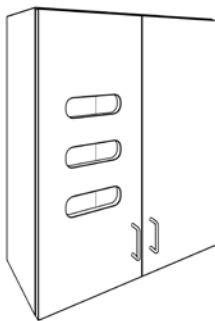

LW122 Left Glove Dispenser (shown) LW123 Right Glove Dispenser				
Width	Height	Depth	Shelves	Description
30"	30"	13"	2	Double Solid Door Glove/Tissue Dispensing Wall Cabinet w/Partition
33"	36"	15"	2	
36"	42"		3	Towel and Cup Dispenser (See Options & Accessories)
	48"		3	

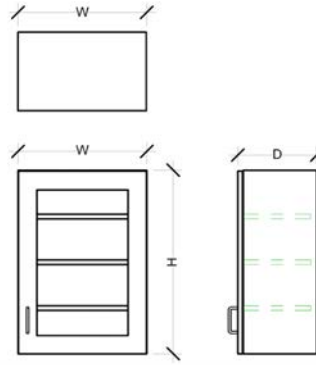

Wall Cabinets

CORNER WALL CABINETS

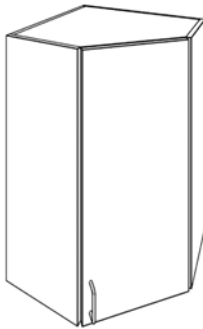

LW130 Left Hinge LW131 Right Hinge (shown)				
Width	Height	Depth*	Shelves	Description
24"	30"	13"	2	Corner Solid Door Wall Cabinet
26"	36"	15"	2	
	42"		3	
	48"		3	

*Depth does not include door

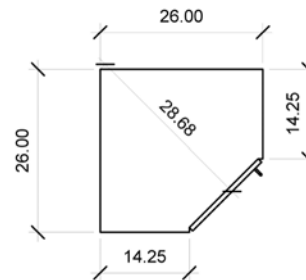
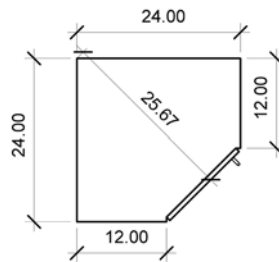

LW132 Left Hinge LW133 Right Hinge (shown)				
Width	Height	Depth*	Shelves	Description
24"	30"	13"	2	Corner Glass Door Wall Cabinet
26"	36"	15"	2	
	42"		3	Interior Matches Exterior
	48"		3	

*Depth does not include door

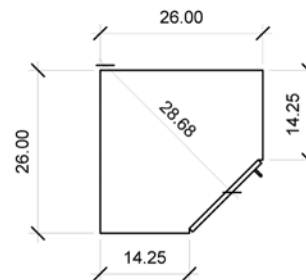
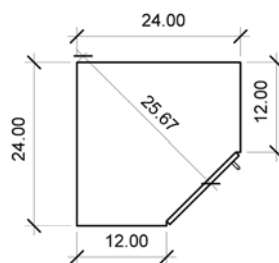

For questions or to place an order, contact our customer service department at **618-503-9171** or **877-302-7755** or by email at sales@cooperworksind.com.

Wall Cabinets

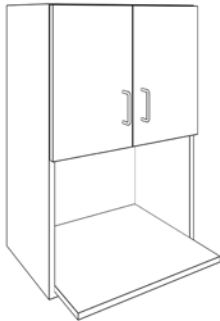
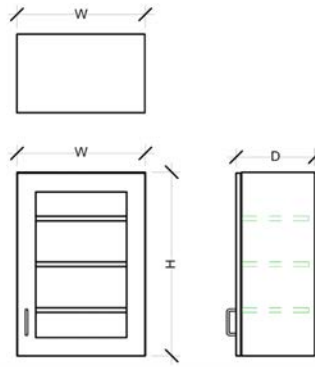

LW140				
Width	Height	Depth	Shelves	Description
24"	30"	13"	[1] 19"	Microwave Solid Door 15.5" Open Height
27"	36"	15"		
30"				Exposed Interior Matches Exterior
33"				
36"				Light Apron*

*Contact factory for ordering details.

WALL SHELVES



S100			
Width	Depth	Brackets per Shelf	Description
24"	12"	2	One-Tier Wall Shelf Specify finish when ordering
36"	14"	3	
48"	16"	3	
60"	18"	3	
72"	20"	3	
84"	22"	5	
96"	24"	5	

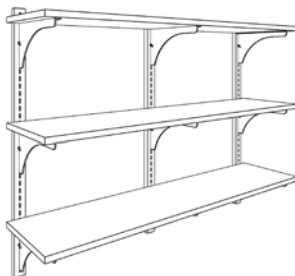

AS101			
Width	Depth	Brackets per Shelf	Description
24"	12"	2	Three-Tier Adjustable Wall Shelf Specify finish when ordering
36"	14"	3	
48"	16"	3	
60"	18"	3	
72"	20"	3	
84"	22"	5	
96"	24"	5	

High Cabinets



STANDARD FEATURES

- Self-close hinges
- White melamine finished tops

OPTIONS & ACCESSORIES

See pages 32-35.

- Locks
- Hinges
- Pulls
- Slope Top
- Soffit
- Loose Plywood Base
- Loose Stainless Steel Base
- Loose Stainless Steel Toe Kick Skin (3-7/8" x 96" field cut to size)

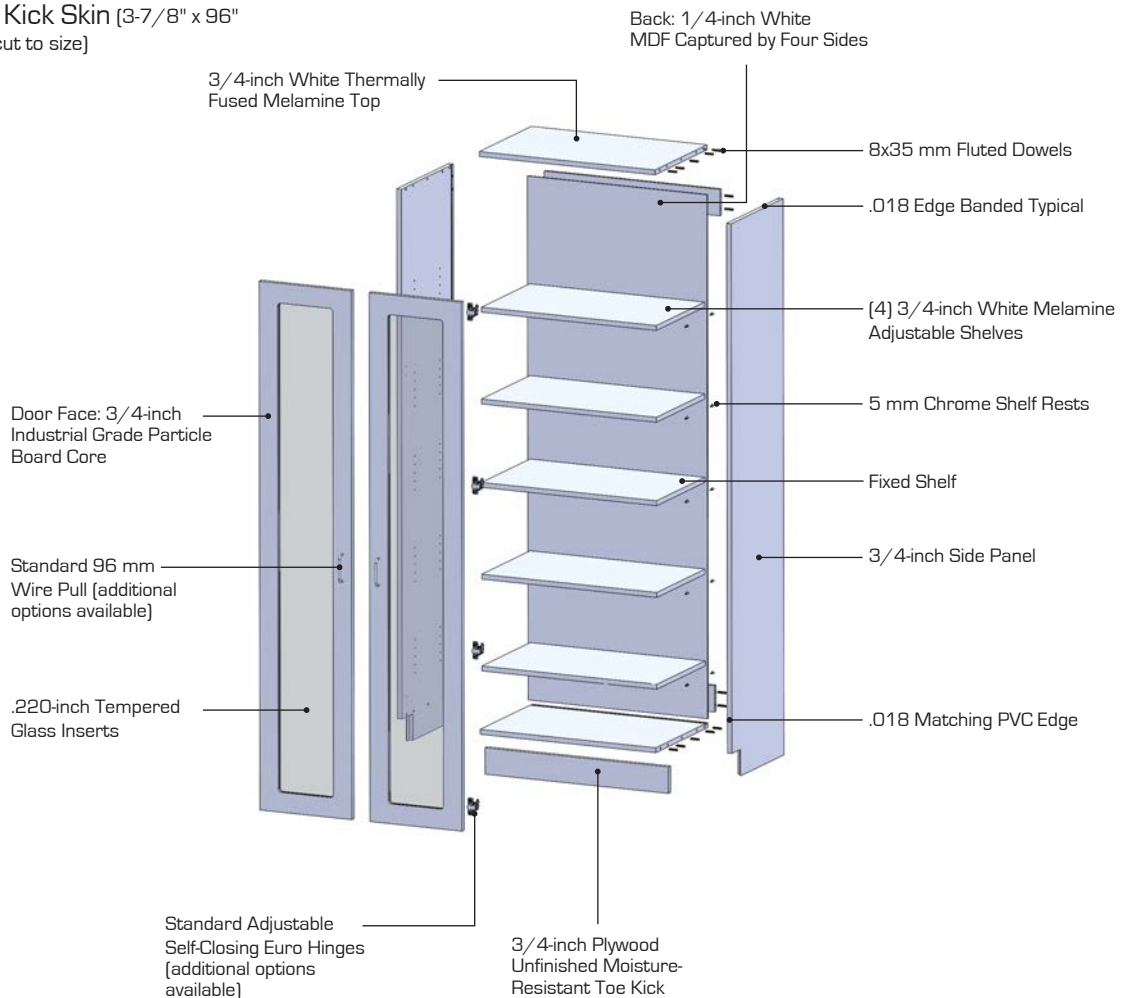

High Cabinets

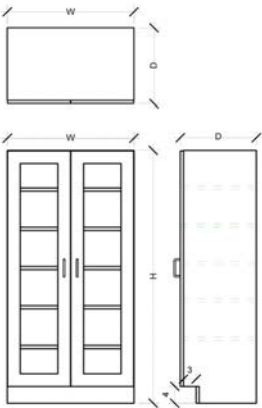

LH100 Left Hinge LH101 Right Hinge (shown)			
Width	Height	Depth	Description
15"	60"	18"	Single Solid Door High Cabinet
18"	72"	21"	(1) Fixed Middle Shelf
21"	84"	24"	(4) Adjustable Shelves
24"	90"		

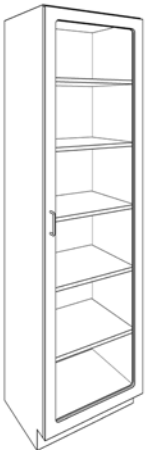

LH102 Left Hinge LH103 Right Hinge (shown)			
Width	Height	Depth	Description
15"	60"	18"	Single Glass Door High Cabinet
18"	72"	21"	(1) Fixed Middle Shelf
21"	84"	24"	(4) Adjustable Shelves
24"	90"		Interior Matches Exterior

High Cabinets

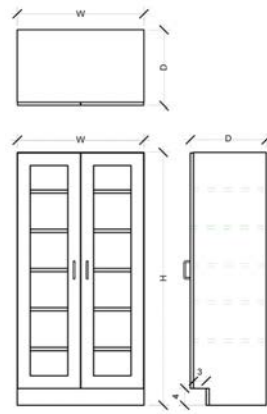

High Cabinets



LH110			
Width	Height	Depth	Description
24"	60"	18"	Double Solid Door High Cabinet (1) Fixed Middle Shelf (4) Adjustable Shelves
27"	72"	21"	
30"	84"	24"	
33"	90"		
36"			



LH111			
Width	Height	Depth	Description
24"	60"	18"	Double Glass Door High Cabinet (1) Fixed Middle Shelf (4) Adjustable Shelves Interior Matches Exterior
27"	72"	21"	
30"	84"	24"	
33"	90"		
36"			

High Cabinets

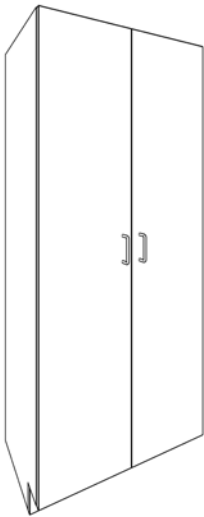
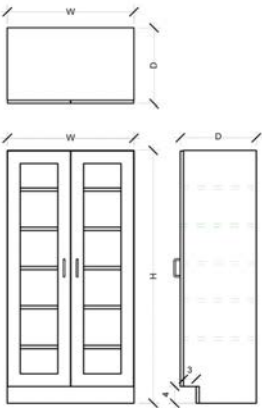

LH120 Left Wardrobe (shown) LH121 Right Wardrobe			
Width	Height	Depth	Description
24"	60"	18"	Double Solid Door Wardrobe Cabinet
27"	72"	21"	
30"	84"	24"	(3) Wardrobe Hooks
33"	90"		(2) Fixed Shelves
36"			(5) Adjustable Shelves

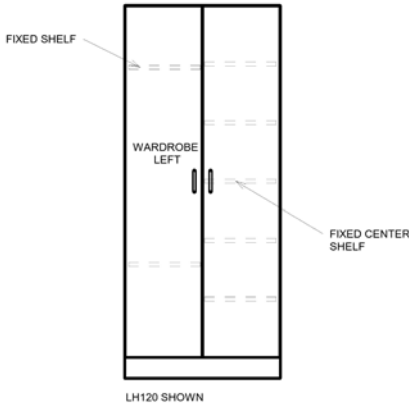

High Cabinets

For questions or to place an order, contact our customer service department at **618-503-9171** or **877-302-7755** or by email at sales@cooperworksind.com.

INTEGRATE™ HPL Cabinet Colors

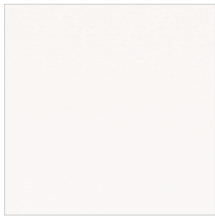

Arctic White



Crisp Linen



White Cypress



Italian Silver Ash



Field Elm



Fusion Maple



Pasadena Oak

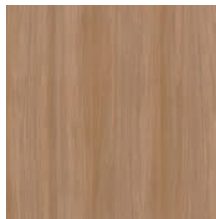

Uptown Walnut

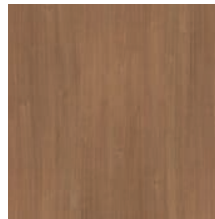

River Cherry

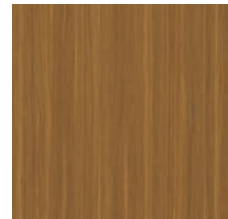

Sap Walnut



Tuscan Walnut

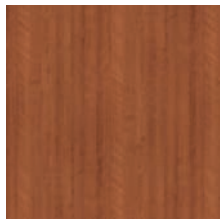

Amber Cherry

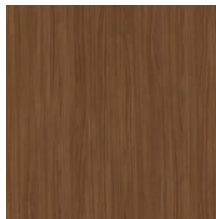

Walnut Heights

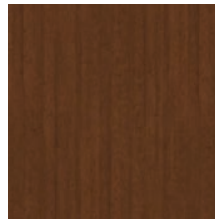

Shaker Cherry

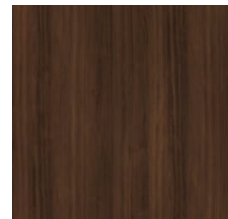

Colombian Walnut

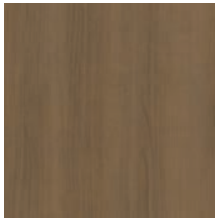

French Pear

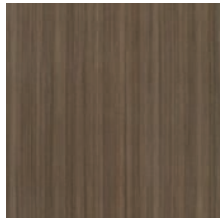

Studio Teak



Veranda Teak



Pewter Mesh



Satin Stainless

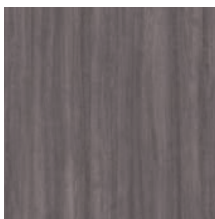

Sterling Ash

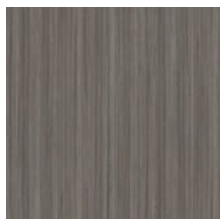

Portico Teak

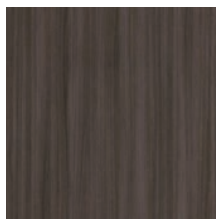

Skyline Walnut

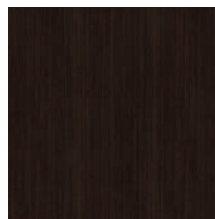

Ebony Recon

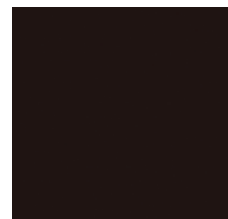

Black

For more color selections contact your sales representative.

INTRIGUE™ TFL Cabinet Colors

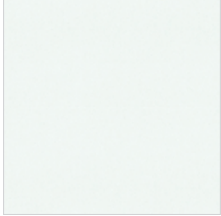

White



Almond



Pearl White



Morning Fog



White Zebrine



Gregio Pine

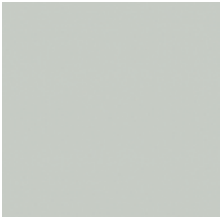

Folkstone



Fog Grey



Hard Rock Maple



Fusion Maple



Caramel Apple



Wild Apple



Amber Cherry

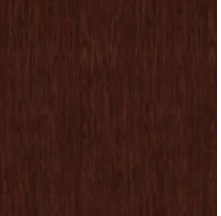

Figured Mahogany

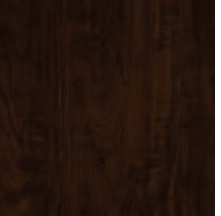

Chocolate Apple

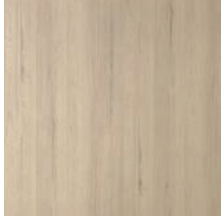

Siberian



Sabbia



Richmond Cherry



Canella Rustik

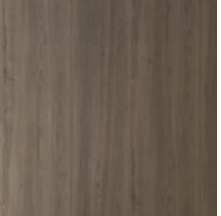

Kyushu

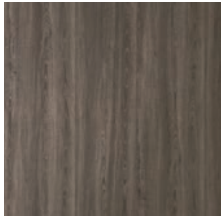

Alno

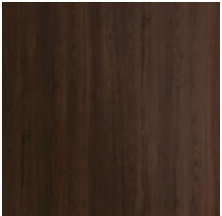

Aliso



Brazilian Walnut



Black



Black Ice

For more color selections contact your sales representative.

Cabinet Colors

INSPIRE™ Vinyl Foil Cabinet Colors



Stratus



Winter



Mist



Swiss Elm

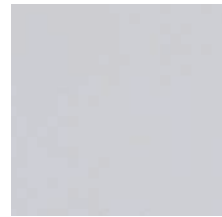

Fashion Grey

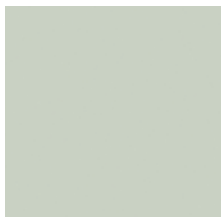

Aloe

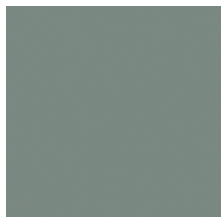

Sage

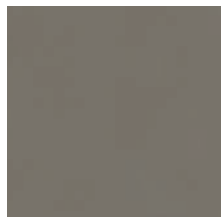

Gauntlet



Wharf

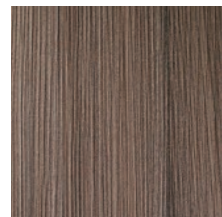

Outer Banks

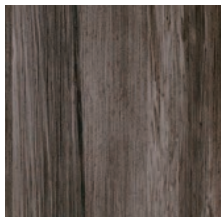

Royal Canyon

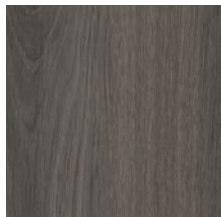

Gibraltar

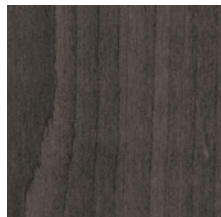

Valencia



Hard Rock Maple

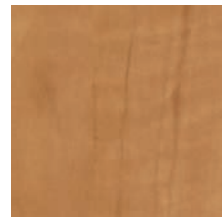

Candlelight

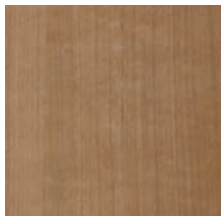

Dolce Vita

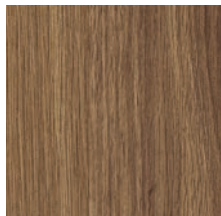

Palomino

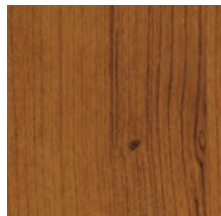

Rustic Cherry

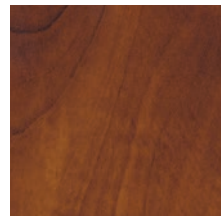

Summerflame

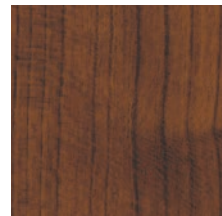

Cherry Blossom

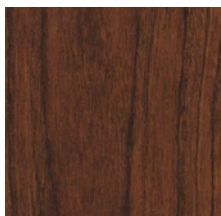

Choco Cherry

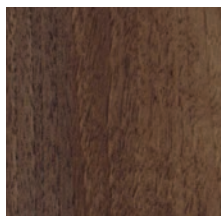

Amati Walnut

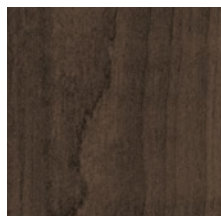

Havana

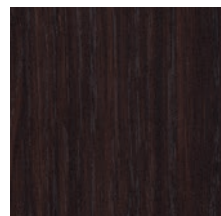

Coffee Bean

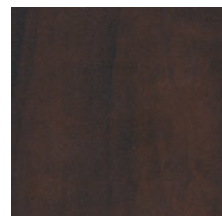

Chocolate Pear

For more color selections contact your sales representative.

Plastic Laminate Countertop Profiles

144" maximum length available. Other front edge options available.

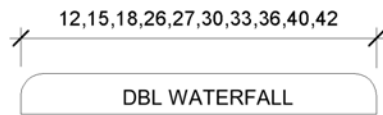
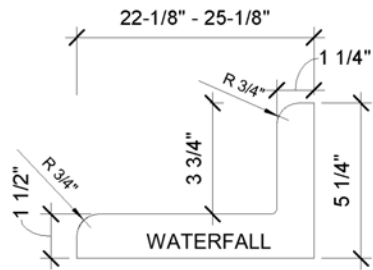
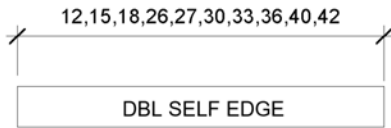
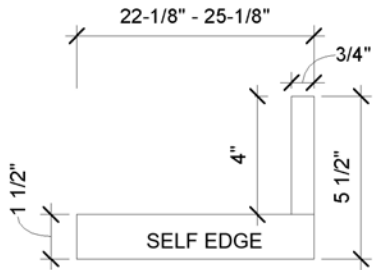
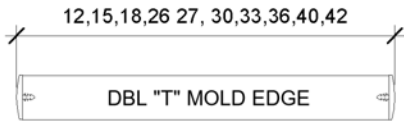
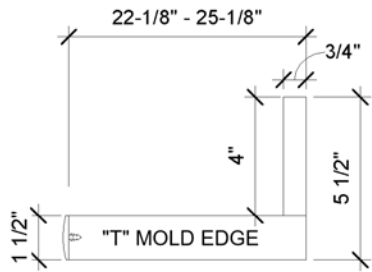
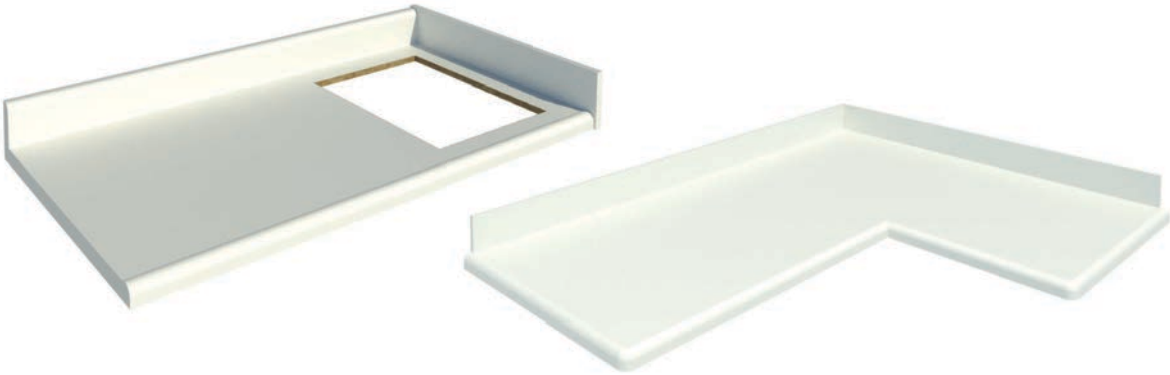

Laminate Countertops

Plastic Laminate Countertop Profiles

144" maximum length available. Other front edge options available.

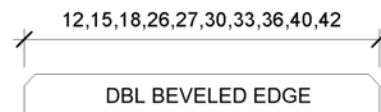
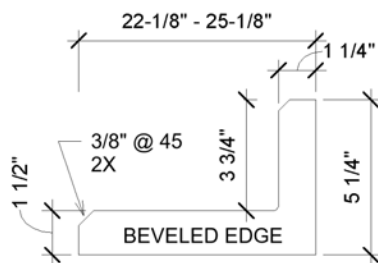
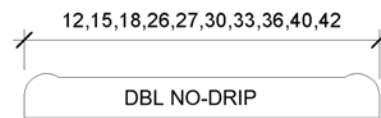
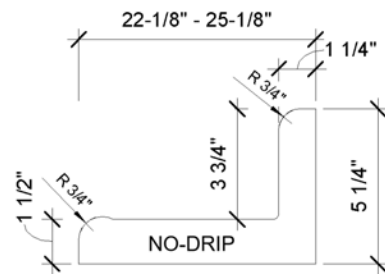
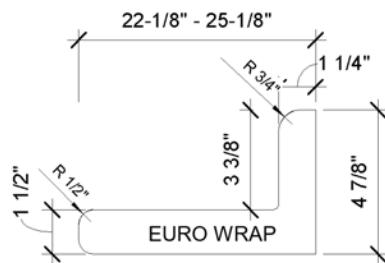
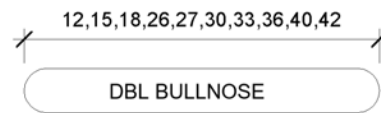
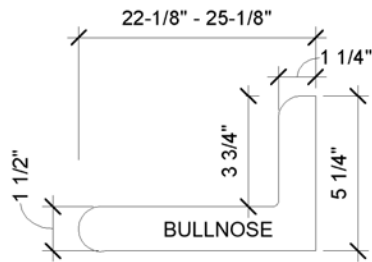

Plastic Laminate Countertop Colors

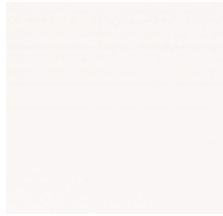

White



Ribbon Marble



Luna Winter



Grey Nebula



Kalahari Topaz



Grey

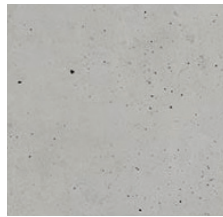

Backyard Patio



Benjamin Grey



Madura Pearl



Cafe Di Pesco

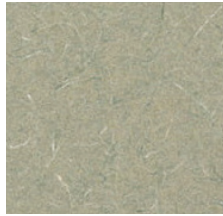

Green Tigris



Bronze Legacy

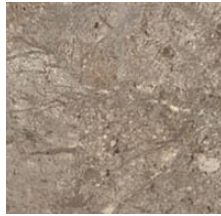

Mocha Fantastico



Madura Gold



Oxide



Milano Quartz

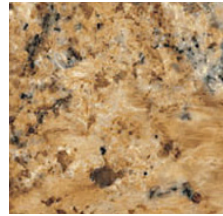

Typhoon Gold

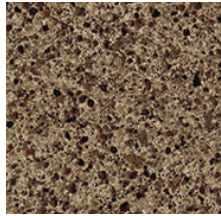

Henna Vesta



Mystique Night



Smoky Topaz



Ebony Fusion



Graphite Nebula

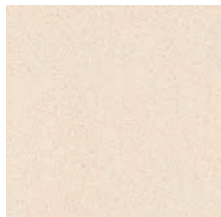

Antimicrobial
Classic Rock

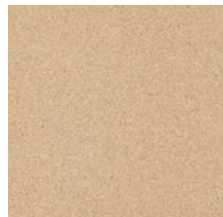

Antimicrobial
House Rock



Antimicrobial
Madura Gold Granite

For more color selections contact your sales representative.

Laminate Countertops

Solid Surface Countertop Profiles

144" maximum length available.

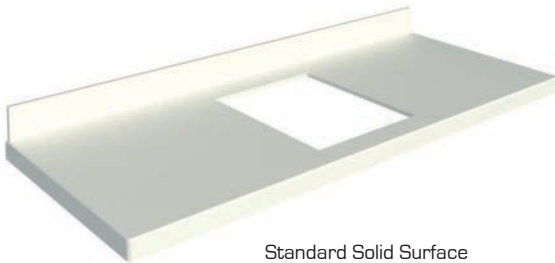

Standard Solid Surface
Countertop



14 gauge (.075nom) 304 #4
Finish Stainless Steel Countertop
with Integral Sink

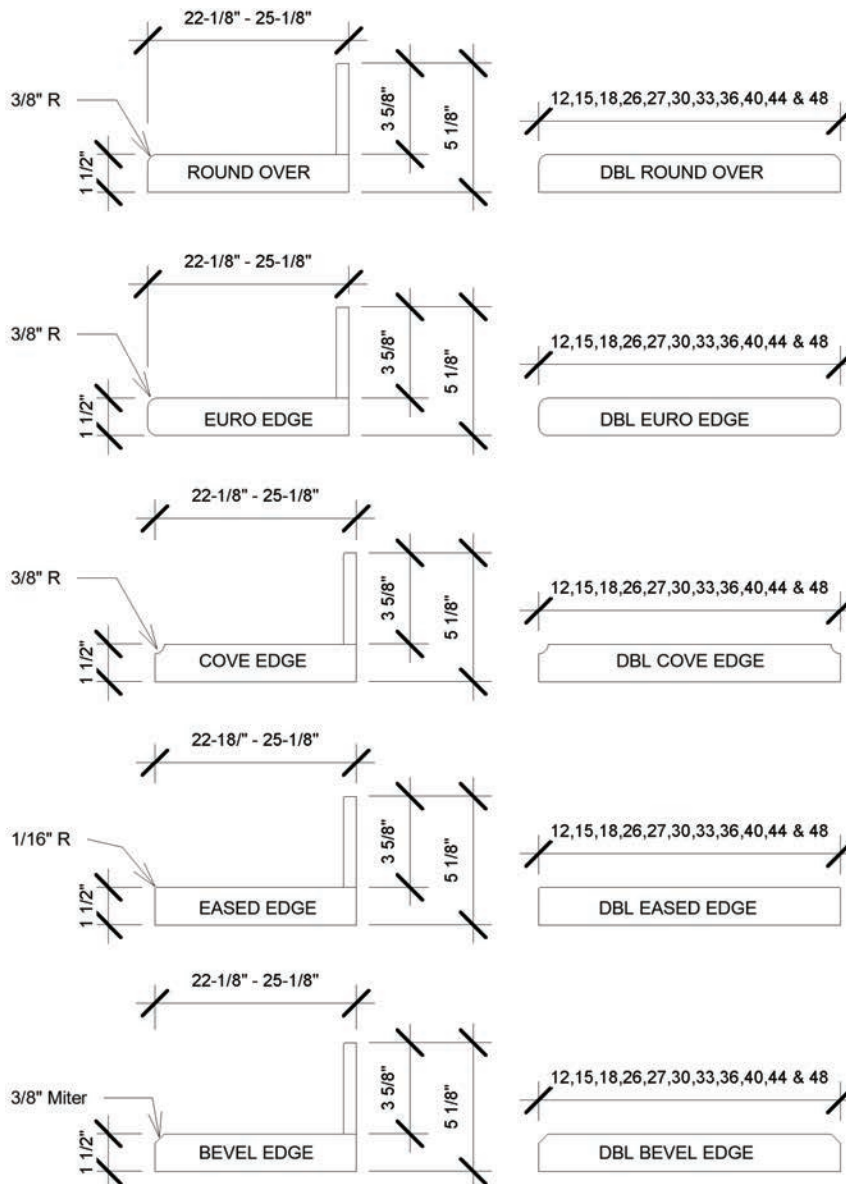

Solid Surface Countertop Colors

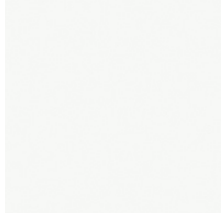

Frosty White

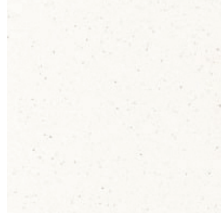

Frosty White Mirage



Milk Glass Spectra



Chai Cream

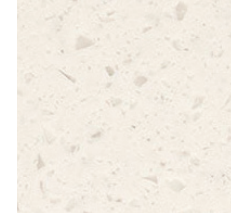

Yukon Riverstone

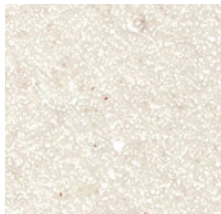

Pearl Mirage



Arctic Melange



Chilled Earth



Cashmere Mirage



Marzipan Mirage

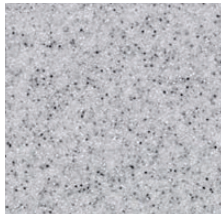

Grey Tempest

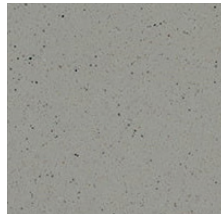

Zen Grey

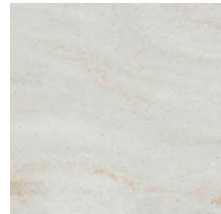

Beige Travertine
(Premium)



Whitewater
(Premium)



Iron Falls
(Premium)

For more color selections contact your sales representative.

Premium Quartz Countertop Colors

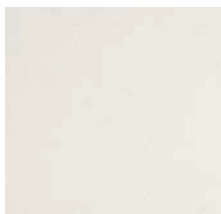

Blizzard

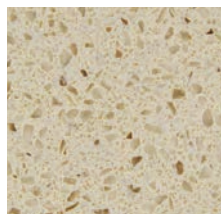

Sand Dollar

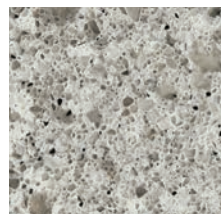

Atlantic Salt

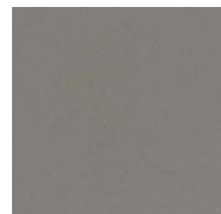

Cement

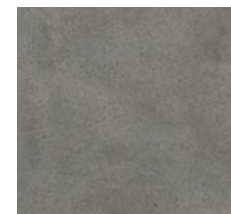

Concrete

For more color selections contact your sales representative.

For questions or to place an order, contact our customer service department at **618-503-9171** or **877-302-7755** or by email at **sales@cooperworksind.com**.

Options & Accessories

SINKS



S.S. Undermount Single Bowl
23"x17"x9"



S.S. Undermount Rectangle
Single Bowl 23"x17"x9"



S.S. Undermount Rectangle
Equal Double Bowl 32"x18"x5.5"



S.S. Drop-In Single Bowl
2 Hole 15"x15"x6"



S.S. Drop-In Rectangle
Single Bowl 3 Hole 15"x15"x6-1/8"



S.S. Drop-In Rectangle Equal
Double Bowl 4 Hole 33"x22"x8"



China Undermount Oval
Solid Surface 18"x14-3/4"



China Undermount Rectangle
Solid Surface 19-1/2"x14-15/16"



China Drop-In 3-Hole
4-in Centerset 19"x19"



Integral Solid Surface
Oval Undermount 18"x13"



Integral Solid Surface
Rectangle Undermount 27"x18"



Integral Solid Surface Undermount
Rectangle Equal Double Bowl 16"x30"

Options & Accessories

FAUCETS



Gooseneck Deck Mount with 8-in Center



Gooseneck Deck Mount with 4-in Center



Gooseneck Deck Mount with 8-in Center



Gooseneck Sensor Faucet



Standard Sensor Faucet

DOOR STYLES

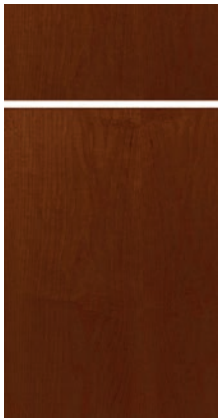

Slab (HPL and TFL)



Five-Piece Shaker (TFL)

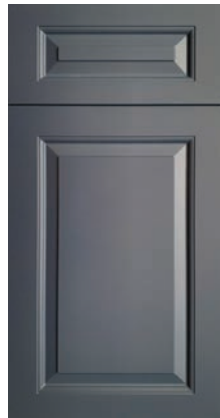

Classic (Vinyl Foil)

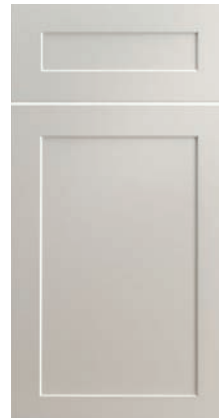
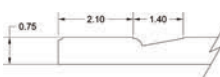

Shaker Shallow (Vinyl Foil)

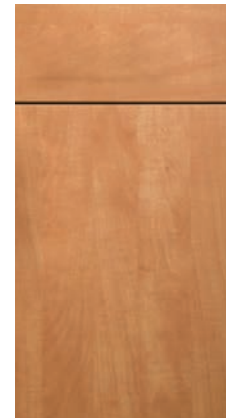
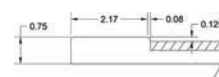

Elegante Smooth Slab (Vinyl Foil)

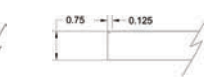

Material and color selections vary by door style. For HPL color selections see page 24. For TFL color selections see page 25. For Vinyl Foil color selections see page 26.

HINGES



Self Close



Soft Close



Five Knuckle Stainless Steel Hospital Grade

Options & Accessories

DOOR PULLS

For additional styles and finishes contact your sales representative.



Bar
Brushed Nickel



Bow
Brushed Nickel



96 mm * (3-3/4") Wire
Brushed Nickel



Antimicrobial Copper
by Cuverro®

* 128 mm (5") Wire also available

BASE CABINET OPTIONS

Custom base sizes available.



Loose Plywood Base



Loose Stainless Steel Base
(Fabricated to size)



Loose Stainless Steel Toe Kick Skin
(3-7/8" x 96" Field cut to size)

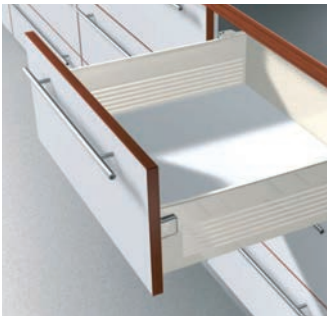

White Metal Drawer Slide



Full Extension Slide



Soft Close Slide

WALL CABINET OPTIONS

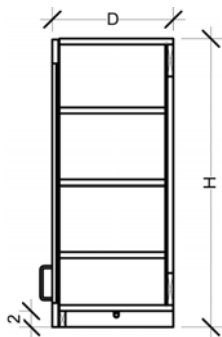

Light Apron

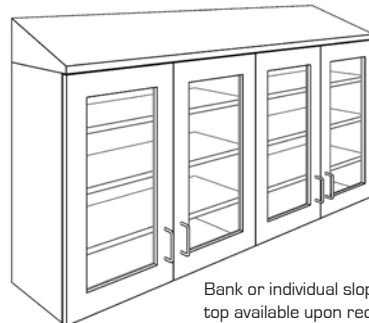

Slope Top

Bank or individual sloping top available upon request.

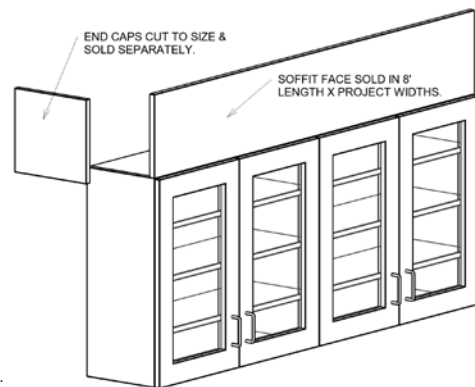

Soffit

Options & Accessories

HIGH CABINET OPTIONS

Custom base sizes available.



Loose Plywood Base

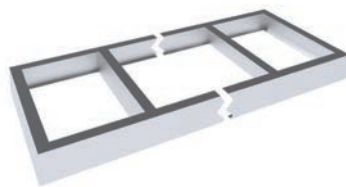

Loose Stainless Steel Base
(Fabricated to size)



Loose Stainless Steel Toe Kick Skin
(3-7/8" x 96" field cut to size)

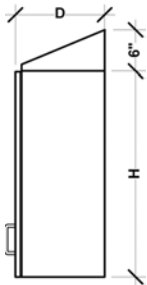

Slope Top

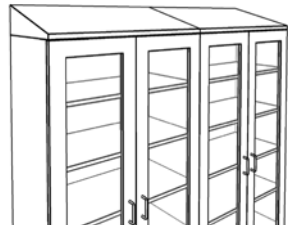

Bank or individual
sloping top available
upon request.

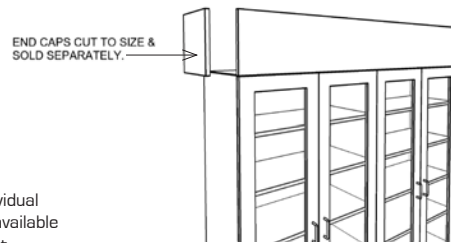

Soffit

ACCESSORIES FOR CABINETS



Digital E-Lock



Cam Lock
(Keyed separately or keyed alike)



3/4-inch End Panel



End Panels with Attached
3-inch Filler, Left or Right
(Backside finished white)

ACCESSORIES FOR COUNTERTOPS



12" x 12"



15" x 15"



18" x 18"



18" x 24"



24" x 29"

A&M Braces



2-3/8" Wire



12" Stainless Steel Wire



6" Trash Wire

Grommets



Green Initiative

Cooperworks Industries is committed to making sound decisions to manage our carbon footprint and protect the environment. Our company-wide green initiative considers our impact on the planet and supports our commitment to sustainability.



Recycled Material

Cooperworks' corrugated packaging products have a recycled content of 36%. This is comprised of 30% post-consumer fiber (recycled boxes) and 6% pre-consumer fiber (waste created at the mills that is recycled).

This catalog is printed using 10% recycled paper which equals 1 ton less wood (7 trees saved), 170 gallons less waste water, 440 lb less CO₂ emissions, and .03 million BTU of energy saved.



Facility Lighting

Cooperworks' manufacturing facilities have been outfitted with energy efficient LED lights. LED lights provide a longer operational lifespan and an overall reduction in wattage used.



Manufacturing Practices

Cooperworks practices lean manufacturing, enabling us to deliver high quality products at lower costs and ultimately minimizing our impact on the planet. Our investment in state-of-the-art technology allows for the maximization of each sheet used in production, and minimizes landfill waste.

Warranty Information



3 Year Certificate of Warranty

Cooperworks Industries, LLC, warrants, for a period of three (3) years from the date of installation, the product manufactured by it to be free from defects in material and workmanship when properly installed under normal use. Some variation in the finishes of these products is characteristic, in terms of color and texture, and does not constitute a defect. Cooperworks Industries assigns to the original purchaser, to the extent assignable and without recourse to Cooperworks Industries, any manufacturer's warranty covering component parts of the product. Defective products shall be repaired or replaced at Cooperworks Industries' option at no cost to the original purchaser provided:

- The customer must obtain a written return authorization supplied by Cooperworks Industries' customer service department. The product must be returned, properly packaged, with a copy of the original sales receipt and copy of the RMA authorization. Please call (877) 302-7755 or (618) 503-9171 to receive a return authorization.
- The customer must pre-pay freight charges to and from Cooperworks Industries and must ship merchandise properly packaged, in a way the product will not be damaged during transit to the factory. Cooperworks Industries does not warranty any freight damage to or from the factory. It is the customer's responsibility to inspect the product for packaging damage before signing the BOL.

It is expressly understood and agreed that the limit of Cooperworks Industries' liability shall be, at Cooperworks Industries' sole option, the repair or re-supply of a like quantity of non-defective product, and that Cooperworks Industries shall have no such liability except where the damage results solely from a breach of Cooperworks Industries' warranty. Any claim under this warranty shall be deemed waived unless made in writing and received by Cooperworks Industries within thirty (30) days of the date the defect to which each claim is discovered or would have been discovered, and no later event than three (3) years as aforesaid. The term "original purchaser" as used herein, shall be deemed to mean that party for whom the product is originally installed.

This warranty does not apply to products, which have been subject to abuse, misuse, accident, modification, alteration, tampering, negligence, lack of routine maintenance or misapplication; or products that have been repaired by other than Cooperworks Industries or its authorized representatives. Additionally, this warranty does not apply to component parts not manufactured by Cooperworks Industries. For these component parts, Cooperworks Industries will pass on the original manufacturer's warranty to Cooperworks Industries equipment original purchasers. Please consult factory for questions regarding the warranties of these component parts.

This warranty is expressly in lieu of any and all other warranties, expressed or implied, including the warranties of merchantability and fitness for a particular purpose. Cooperworks Industries makes no other representations or warranties of any kind, and shall not be liable for any incidental, consequential or other damages for any alleged negligence, breach of warranty, or upon any other theory, other than the limited warranty first set forth above. No representative has any authority to change or enlarge the above warranty or Cooperworks Industries' liability. This document supersedes all previous warranty provisions.



Creating unique spaces.



COOPERWORKS
INDUSTRIES

Cooperworks Industries LLC
A Division of MAC Medical, Inc.
200 Admiral Weinel Blvd.
Columbia, Illinois 62236

Phone: (618) 503-9171 • Toll Free: 877-302-7755 • www.cooperworksind.com

Printed in USA
Publication No. CFU-03 Rev A
October 2020

Information regarding products is subject to change without prior notice.